

**ZXT-120**  
**(Z-Wave-to-AC IR Extender)**

**USER MANUAL**

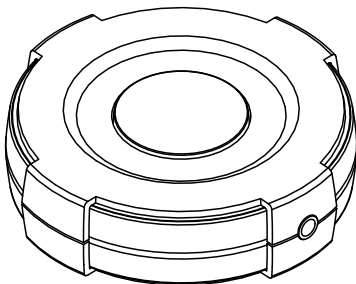

# Table of Contents

<b>Introduction</b> .....	<b>2</b>
<i>Controller and Gateway Requirements</i> .....	3
<i>Built-in IR code library</i> .....	3
<i>Glossary</i> .....	3
<i>Product Overview</i> .....	5
<b>Setup and Operations</b> .....	<b>6</b>
<i>Listening Mode</i> .....	6
<i>Inclusion/Exclusion</i> .....	7
<i>IR Code Selection</i> .....	8
<i>IR Code Learning</i> .....	9
<i>Reset ZXT-120 to factory default</i> .....	14
<i>ZXT-120 Information</i> .....	14
<i>Z-Wave Configuration Parameters</i> .....	15
<b>Installation</b> .....	<b>18</b>
<i>Mounting the ZXT-120 to a wall</i> .....	18
<b>Wireless Information</b> .....	<b>21</b>
<b>Maintenance</b> .....	<b>21</b>
<b>Frequently Asked Questions</b> .....	<b>22</b>
<b>Technical Specifications</b> .....	<b>24</b>
<b>Checking Accessories</b> .....	<b>25</b>
<b>FCC Notice</b> .....	<b>25</b>
<b>Warnings</b> .....	<b>26</b>
<b>Caution</b> .....	<b>26</b>

# Z-Extender™ ZXT-120

(Z-Wave-to-AC IR Extender)

## Introduction

The ZXT-120 is a Z-Wave to IR extender for air-conditioner (AC), (Figure 1), it works with any Z-Wave compliant gateway or controller by translating Z-Wave Thermostat Commands to AC IR control code. User can select the IR code from the built-in code library of ZXT-120, or use learning function, by using Z-Wave Configuration Commands according to the parameter table. ZXT-120 is also with built-in temperature sensor which allows gateway or controller to get the current room temperature.

Figure 1 ZXT-120

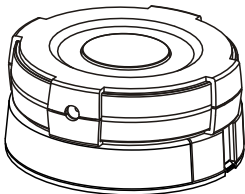

ZXT-120 can be configured as either "**Frequently Listening Routing Slaves**" FLiRS (if you are using battery) or "**Always Listening**" (if you are using 5Vdc adaptor) before inclusion process. Refer to Glossary for definition of "FLiRS" and "Always Listening" mode.

ZXT-120 supports Network Wide Inclusion (NWI) and Explore Frames. It also supports Z-Wave networks with multiple gateways and controllers. Once the configuration and setup is complete, the gateway or controller can use Z-Wave "Thermostat commands class" to control their IR-controlled air-conditioner through the ZXT-120.

## Controller and Gateway Requirements

The ZXT-120 can work with any Z-Wave compliant controller or gateway supporting the following Z-Wave commands.

- Configuration Command Class
- Multilevel Sensor Command Class
- Thermostat Command Class
  - > Thermostat Mode Command Class
  - > Thermostat Fan Mode Command Class
  - > Thermostat Set-point Command Class

## Built-in IR code library

The Built-in IR code library supports most of the popular air conditioner brands in the market. Z-Wave gateway and controller does not need to have any IR control code knowledge. User can use Z-Wave controller or gateway to select the IR code according to the ZXT-120 code list separately provided through Z-Wave configuration command.

## Glossary

<b>Device or Node</b>	Devices and nodes are all terms to describe an individual Z-Wave device. These are all interchangeable when setting up your Z-Wave network.
<b>Inclusion</b>	Add a Z-Wave device to the network.
<b>Exclusion</b>	Delete a Z-Wave device to the network.
<b>Remove</b>	To take a device out of a group, scene or association group while that device still exists in the same Z-Wave network.

<b>Z-Wave Network</b>	A collection of Z-Wave devices is controlled by primary and secondary controllers operating on the same system. A Z-Wave network has its own unique ID code so that controllers not in the network cannot control the system.
<b>Primary Controller</b>	The first controller is used to set up your devices and network. Only the Primary Controller can be used to include or delete devices from a network. It is recommended that you mark the primary controller for each network for ease in modifying your network.
<b>Network Wide Inclusion (NWI)</b>	Network Wide Inclusion (NWI) enables both end-user friendly, Plug and Play like Z-Wave network installation as well as professional installation scenario where the inclusion process in terms of time will be reduced significantly. NWI is a feature supported by a new frame type named Explorer which enables the Z-Wave protocol to implement Adaptive Source Routing.
<b>FLiRS Mode</b>	FLiRS is abbreviation for "Frequently Listening Routing Slave". FLiRS mode is targeted for battery operated applications and will enter sleep mode frequently in order to conserve battery consumption. The response to Z-Wave command is not as quick as Always Listening Device. Normally there is 1-2 seconds latency.
<b>Always Listening Mode</b>	Always Listening mode is targeted for AC power operated applications and it can act as a repeater, which will re-transmit the RF signal to ensure that the signal is received by its intended destination by routing the signal around obstacle and radio dead spots. The response to Z-Wave command is immediate.

## Product Overview

1. "PROG" Button, Learning and LED Indication
2. Temperature sensor
3. External IR Port
4. USB Power 5V DC
5. Battery chassis

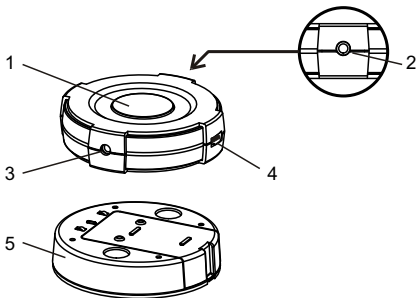
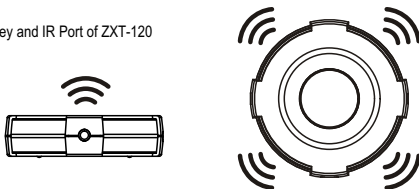

Figure 2  
PROG Key and IR Port of ZXT-120



Surround IR Output for top and 4-directions

## Setup and Operations

Before using the ZXT-120, please read the [INSTALLATION] if you need to mount the ZXT-120 to a wall. Power up the ZXT-120 by the USB Power 5Vdc or Dry battery AAA x 3pcs.

- Plug-in 5Vdc power into the USB socket if operated at Always Listening mode. Or
- Install 3xAAA batteries if operated at FLiRS mode.
- Please refer to the section of [MOUNTING PROCEDURE].
- Remove the battery cover on the back of your ZXT-120 battery chassis.
- Mount the battery cover into the main unit with 2 screws.
- Check the polarity of the batteries and the "+/-" marks inside the battery compartment.
- Insert the batteries.
- Push the battery cover and main unit back in place.

### CAUTION (battery and power adaptor safety)

- Use new batteries of the recommended type and size only.
- Never mix used and new batteries together.
- To avoid chemical leaks, remove batteries from the ZXT-120 if you do not intend to use the remote for an extended period of time.
- Dispose of used batteries properly; do not burn or bury them.

(Please carefully read through the following then store the manual for future reference.)

## Listening Mode (default mode is FLiRS)

ZXT-120 can be configured as either "**Frequently Listening Routing Slaves**" FLiRS (if you are using battery) or "**Always Listening**" (if you are using 5Vdc adaptor) before inclusion process. Refer to Glossary for definition of "FLiRS" and "Always Listening" mode.

### Important:

It is not allowed to changing ZXT-120 listening mode without exclusion process (do not change ZXT-120 listening mode while ZXT-120 is included in a network).

## How to switch ZXT-120 listening mode from "Always Listening" to "FLIRS" (or vice verse)

Step	Setup Key	LED Indication Status on ZXT-120
1	Press and hold the PROG button on the ZXT-120 for around 5 seconds	- LED turns ON after PROG key hold for 5seconds
2	Release the button and then press the PROG button 3 times within 2 seconds	- LED flashes twice then stay off (ZXT-120 set in FLIRS mode)  OR  - LED flashes four times then stay off (ZXT-120 set in Always Listening mode)

## Inclusion/Exclusion

Step	Setup Key	LED Indication Status on ZXT-120
1	Refer to your primary controller instructions to process the inclusion/exclusion setup procedure.	
2	When prompted by your primary controller, <u>click once on the PROG button</u>	- LED flashes once then stay off (ZXT-120 will report the supported command class)

The primary controller should indicate that the action was successful. If the controller indicates the action was unsuccessful, please repeat the procedure.



## IR Code Selection

ZXT-120 is with built-in IR AC code library, user may select the IR code using Configuration Command Class.

Step	Setup Key	LED Indication Status on ZXT-120
1	After included ZXT-120 to Z-Wave controller or Gateway, go to device setup for configuration on gateway or controller.	
2	Input parameter number "27" and parameter value (please look up the code list of ZXT-120 according to your AC brand). Then complete the configuration process.	- LED flashes twice when ZXT-120 receives the configuration setting
3	Press the PROG button on the ZXT-120. (this step apply when using ZRC-100 or other portable controller for set up, if using gateway, user can skip this step)	- LED flashes twice when ZXT-120 receives the configuration setting
4	Go back to the control page of ZXT-120 on the gateway and try the function such as (cool, temperature set).  If the air conditioner does not respond to the command you set on Gateway (Cool, Heat, Auto, Temperature set etc.), repeat step 2 and 3 to select the next code on code list.	- LED flashes once every time it receives a command from gateway

## **i** Important Information

- Different brand or model of air conditioner has different function. For example, some air conditioner only support temperature set from 18 °C - 30 °C, if user set 17 °C on gateway, ZXT-120 will not respond.
- There are more than 1 code for each brand, some does not support heat, if user selected a code that does not support heat but the original air conditioner supports heat function, please continue to try next code until the correct one is selected.
- You can record down your device code for future reference after setting up the ZXT-120 correctly.

AC device programmed to your ZXT-120

Code no.: \_\_\_\_\_

- If none of the code works on the target air conditioner, or the air conditioner brand is not shown on the code list, please select code "000" for IR code learning (refer to instruction of IR Code Learning)

## IR Code Learning

In case none of the code on the code list works for the targeted air conditioner, user can use IR code learning function using configuration according to below steps:

Step	Setup Key	LED Indication Status on ZXT-120
1	Go to configuration setting page on the gateway or ZRC-100 and input parameter number "27" and parameter value "000" to select the dedicated AC code number "000" for learning.	- LED flashes twice when ZXT-120 receives the configuration setting.

Step	Setup Key	LED Indication Status on ZXT-120
2	<p>Look up below mapping table (value 0-22) for learning, and decide the IR setting you intent to learn next.</p> <p>For example "22 °C, cool" which matches value "5" (IR code to be learnt will locate at "5" in ZXT-120). Set your original air conditioner remote at "22 °C, cool" and turn it off. (Besides temperature and mode, you may set other desired settings, such as Fan, Swing etc.)</p>	
3	<p>Go to configuration setting page on the gateway or ZRC-100 and input parameter number "25" and parameter value "5" (in this case).</p>	
4	<p>Press the PROG button on the ZXT-120. (this step apply when using ZRC-100 or other portable controller for set up, if using gateway, user can skip this step)</p>	<ul style="list-style-type: none"> <li>- LED flashes once when ZXT-120 receives the configuration setting.</li> <li>- LED flashes once again to start learning.</li> </ul>
5	<p>Aim the original air conditioner remote at ZXT-120 according to below position within 1-3 cm</p> <p>original remote      1-3 cm</p>  <p>Press "power on" button on the original air conditioner remote.</p> <p>If the learning is failed, repeat step 3 to step 5.</p> <p>To learn next IR code, repeat step 2 to step 5.</p>	<ul style="list-style-type: none"> <li>- LED flashes twice if learning is successful.</li> <li>- LED flashes 6 times if it's failed.</li> </ul>

**i** When you encounter problem, check followings:

- Make sure your original remote is switched to power off.
- Press the key on original remote before learning mode timeout.
- Keep away from incandescent light and direct sunlight during learning.
- Make sure IR Transmitter of your original remote align with learning diode of ZXT-120, you may also slight adjust closer or further away the distance of two devices. Some of remotes the IR transmitter in hidden behind lens and may not installed center of remote.
- Make sure the power is good on both devices, especially the original remote. Use fresh batteries.

### IR Learning Mapping Table (Parameter number 25)

Parameter Value (Storage Location)	Thermostat command & IR setting	
	Storage in Celsius unit	Storage in Fahrenheit unit
0	OFF	OFF
1	ON (resume)	ON (resume)
2	19 °C cool	67 °F cool
3	20 °C cool	68 or 69 °F cool
4	21 °C cool	70 or 71 °F cool
5	22 °C cool	72 or 73 °F cool
6	23 °C cool	74 or 75 °F cool
7	24 °C cool	76 °F cool
8	25 °C cool	77 or 78 °F cool
9	26 °C cool	79 or 80 °F cool
10	27 °C cool	81 or 82 °F cool
11	28 °C cool	83 or 84 °F cool

Parameter Value (Storage Location)	Thermostat command & IR setting	
	Storage in Celsius unit	Storage in Fahrenheit unit
12	19 °C heat	67 °F heat
13	20 °C heat	68 or 69 °F heat
14	21 °C heat	70 or 71 °F heat
15	22 °C heat	72 or 73 °F heat
16	23 °C heat	74 or 75 °F heat
17	24 °C heat	76 °F heat
18	25 °C heat	77 or 78 °F heat
19	26 °C heat	79 or 80 °F heat
20	27 °C heat	81 or 82 °F heat
21	28 °C heat	83 or 84 °F heat
22	Dry mode	Dry mode

The "IR Learning Mapping Table" is the mapping information "degree C" VS "storage location" or "degree F" VS "storage location". It is not related to "F to C" or "C to F" unit conversion.

## **i** Important Information

After all learning completed, user can go back to the ZXT-120 control page on the gateway for normal operation.

- On the gateway UI, user can only use the temperature range from the mapping table, OFF, ON(RESUME), COOL, HEAT, DRY, If user press the button of FAN, or other function on the gateway UI which is not listed in above table, ZXT-120 will not respond.
- If user only learnt ON, OFF, or part of the settings according to the above table, ZXT-120 will send the learnt data to the air conditioner only. For example, user only learnt ON, OFF, 22 °C Cool, 24 °C Heat, ZXT-120 will not send IR data to air conditioner if user set 27 °C Cool on the gateway.
- ZXT-120 has been pre-defined default cool at 26 °C, default heat at 22 °C, when user press Cool on gateway without setting temperature, ZXT-120 will send the learnt data of 26 °C Cool to air conditioner. When user press Heat on gateway without setting temperature, ZXT-120 will send the learnt data of 22 °C Heat to air conditioner.
- There is only one code for dry mode, user can set it at any preferred temperature.
- User can still use gateway to set up scene and schedule with ZXT-120, for example, to have AC turn on at 23 °C every day at 7pm, 25 °C at 11pm. Just make sure the set code is learnt.
- The learning mapping table is for split air conditioner which remote control is with LCD display. For window type air conditioner (which remote control is without LCD display), the mapping table with temperatures do not apply, due to different type of IR control protocol. However, user may still use the OFF, or ON/RESUME, DRY key for learning. (Because the POWER key on the original remote without LCD display is toggle, user can choose either ON key, or OFF key to learn Power key, after learning is done, press once to turn on the air conditioner if the air conditioner is OFF, press once to turn off if the air conditioner is ON)

## Reset ZXT-120 to factory default

Press and hold "PROG" button for 10 seconds on ZXT-120. During the key hold period, RED LED lights up at around 5 seconds, then, it will flash twice until reset process is completed at around 10 seconds.



### Information

- This reset step will not affect the listening mode of ZXT-120, user should refer to "Listening Mode" section if you want to change the listening mode.
- If you are using Gateway or other Z-wave controllers to operate ZXT-120, please follow the instruction from the gateway or other controller.

## ZXT-120 Information

How to get the NIF "Node Information Frame" on ZXT-120 (Inclusion)?

Setup Key	LED Indication Status on ZXT-120
Press the PROG button on the ZXT-120	- LED flashes once then stay off. (ZXT-120 will report the supported command class)

## Z-Wave Configuration Parameters

Parameter No.	Definitions	Parameter Value
25 (0x19)	Indicate a location for IR code learning and start learning	0-22 (0x00 0x16)
26 (0x1A)	<p>Learning status register</p> <p><b>Note:</b> The status value 0x01 and 0x04 will be reset to 0 when the ZXT-120 receive a get command to this parameter</p>	<p><b>0(0x00):</b> Idle - this IR channel is idle (default)</p> <p><b>1(0x01):</b> OK - the latest learning process successful and completed</p> <p><b>2(0x02):</b> Learning - the ZXT-120 is busy processing previous learning request</p> <p><b>4(0x04):</b> Failed - the latest learning request failed</p>
27 (0x1B)	IR code number for built-in code library	Refer "Code list" for details
28 (0x1C)	External IR Emitter power level	<p><b>0(0x00):</b> normal power mode</p> <p><b>255(0xFF):</b> high power mode (default)</p>
32 (0x20)	<p>Surround IR control</p> <ul style="list-style-type: none"> <li>- to avoid the IR interference by disabling the surrounding IR emitter if 2 air-conditioners in a room are used</li> <li>- extend the battery life by disabling the Surround IR Emitters</li> </ul>	<p><b>0(0x00):</b> disable Surround IR Emitters</p> <p><b>255(0xFF):</b> enable Surround IR Emitters (default)</p>



Parameter No.	Definitions	Parameter Value																
33 (0x21)	AC function "SWING" control	<b>0(0x00):</b> SWING OFF <b>1(0x01):</b> SWING AUTO (Default)																
35 (0x23)	Learn location status	Bit mask = 1, learn location has learn data. Otherwise, Bit mask = 0 See figure " <b>Learn location</b> " as below																
<p>On below example, listed below function has learnt location 1: ON (resume) location 7: 24 °C cool location 8: 25 °C cool location 12: 19 °C heat location 16: 23 °C heat</p>																		
<table border="1"> <tr><td>7</td><td>6</td><td>5</td><td>4</td><td>3</td><td>2</td><td>1</td><td>0</td></tr> <tr><td>1</td><td>0</td><td>0</td><td>0</td><td>0</td><td>0</td><td>1</td><td>0</td></tr> </table>		7	6	5	4	3	2	1	0	1	0	0	0	0	0	1	0	Bit mask Byte 1 Location 0-7
7	6	5	4	3	2	1	0											
1	0	0	0	0	0	1	0											
<table border="1"> <tr><td>7</td><td>6</td><td>5</td><td>4</td><td>3</td><td>2</td><td>1</td><td>0</td></tr> <tr><td>0</td><td>0</td><td>0</td><td>1</td><td>0</td><td>0</td><td>0</td><td>1</td></tr> </table>		7	6	5	4	3	2	1	0	0	0	0	1	0	0	0	1	Bit mask Byte 2 Location 8-15
7	6	5	4	3	2	1	0											
0	0	0	1	0	0	0	1											
<table border="1"> <tr><td>7</td><td>6</td><td>5</td><td>4</td><td>3</td><td>2</td><td>1</td><td>0</td></tr> <tr><td>■</td><td>0</td><td>0</td><td>0</td><td>0</td><td>0</td><td>0</td><td>1</td></tr> </table>		7	6	5	4	3	2	1	0	■	0	0	0	0	0	0	1	Bit mask Byte 3 Location 16-22
7	6	5	4	3	2	1	0											
■	0	0	0	0	0	0	1											
<table border="1"> <tr><td>7</td><td>6</td><td>5</td><td>4</td><td>3</td><td>2</td><td>1</td><td>0</td></tr> <tr><td>■</td><td>■</td><td>■</td><td>■</td><td>■</td><td>■</td><td>■</td><td>■</td></tr> </table>		7	6	5	4	3	2	1	0	■	■	■	■	■	■	■	■	Bit mask Byte 4 (Reserved)
7	6	5	4	3	2	1	0											
■	■	■	■	■	■	■	■											
<p style="text-align: center;"><u>Figure: Learn location</u></p> <p>■ Reserved location</p>																		

Parameter No.	Definitions	Parameter Value
37 (0x25)	<p>Sensor temperature compensation</p> <p>(This parameter is used to compensate the temperature error at temperature sensor)</p>	<p>Temperature offset value.</p> <p>Formula:            Display temperature = sensor reading value + offset value            (unit = degree C)</p> <p>0x00 = 0 °C (Default)            0x01 = 1 °C            0x02 = 2 °C            0x03 = 3 °C            0x04 = 4 °C            0x05 = 5 °C            0xFF = -1 °C            0xFE = -2 °C            0xFD = -3 °C            0xFC = -4 °C            0xFB = -5 °C</p>

### Mapping Information

- BASIC Set Value 0x00 will map to Thermostat mode Off 0x00.
- BASIC set Value 0xFF will map to Thermostat mode Resume 0x05.

## **Installation**

### **Mounting the ZXT-120 to a wall**

#### **MOUNTING LOCATION PRECAUTIONS**

- Before mounting, check the material and structure of the mounting location. If the location does not have the proper material or structure, the ZXT-120 can fall and cause injuries.
- Use commercial items that best match the wall structure and material for the screws and other fixtures.
- Do not mount near a kitchen counter, humidifier, or other location in which it can be exposed to smoke or steam. Doing so could cause a fire or electrical shock.
- Do not mount in locations with high humidity or large amounts of dust. Doing so could cause a fire or electrical shock.
- Do not mount to locations subject to high temperatures, high humidity, or exposure to water. Doing so could cause a fire or electrical shock.
- Do not mount to locations subject to large amounts of vibration, large jolts, or large forces. These could cause an injury if the ZXT-120 falls and breaks.

#### **MOUNTING PROCEDURE PRECAUTIONS**

- Do not modify parts or use the ZXT-120 in ways other than its intended use. Doing so could cause the ZXT-120 to fall and result in an injury.
- Be sure to fully check that there are no electrical wires or pipes inside the wall before mounting.
- If any of the screws are loose, the ZXT-120 can fall and cause an injury. Do not mount the ZXT-120 with the screws still loose.
- Check that the two screws mounted to the wall are fully inserted into the key holes of the ZXT-120. Otherwise, the ZXT-120 can fall and cause an injury.
- Do not mount the ZXT-120 so that it sticks out from the wall edge. It could get hit by people's bodies or objects and cause an injury.
- Supplier will not be liable for any accidents or injuries that occur due to improper mounting or handling.
- When mounting, be careful not to get your fingers pinched or injure your hands.

## MOUNTING PROCEDURE

The ZXT-120 can be mounted to a wall or wooden racks using the two key holes in the bottom case.

**Note 1:** The reception sensitivity varies depending on the antenna direction.

**Note 2:** Before mounting to a wall, be sure to fully read the precautions.

1. Obtain two screws suitable for the wall strength and material. The screw size is shown in the figure below.



2. The positional relationship between the ZXT-120 key holes and the screw mounting positions are shown in the figure below.

**Note 1:** When mounting the screws to the wall, leave a space between the wall and screw cap as shown in the figure.

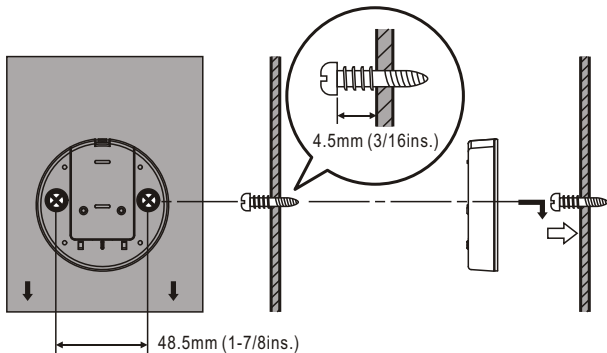

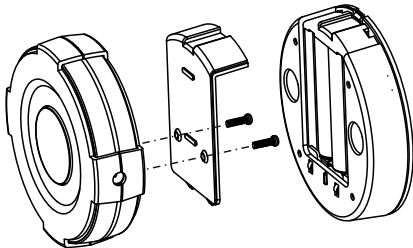

3. Insert the ZXT-120 key holes onto the two screws mounted to the wall, and then slide downward to secure in place.
4. After securing the ZXT-120 to the wall, connect the USB Power or batteries and IR emitter cable to the ZXT-120.

**Note 1:** Check that the ZXT-120 is firmly secured to the wall.

**Note 2:** Insert USB plug or batteries and IR emitter cable so that they are firmly connected to the ZXT-120.

5. When removing the ZXT-120 from the wall, lift up the ZXT-120, then pull it towards you.
6. Detach the main unit from the battery chassis by move toward to top position.

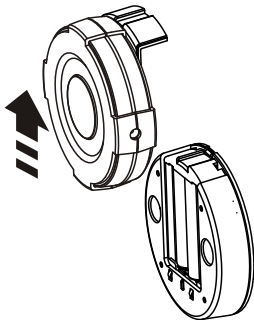

## **Wireless Information**

This device has an open-air line-of-sight transmission distance of 25m which complies with the Z-Wave standards. Performance can vary depending on the amount of objects in between Z-Wave devices such as walls and furniture. Every Z-Wave device set up in your network will act as a signal repeater allowing devices to talk to each other and find alternate routes in the case of a reception dead spot.

Radio frequency limitations:

1. Each wall or object (i.e.: refrigerator, bookshelf, large TV, etc) can reduce the maximum range of 20m by up to 20 to 30%.
2. Plasterboard and wooden walls block less of the radio signal than concrete, brick or tile walls which will have more of an effect on signal strength.
3. Wall mounted Z-Wave devices will also suffer a loss of range if they are housed in metal junction boxes which could also reduce the range by up to 20 to 30%.

## **Maintenance**

1. Do not expose your unit to dust, strong sunlight, humidity, high temperatures or mechanical shocks.
2. Do not use old and new batteries together as old batteries tend to leak.
3. Do not use corrosive or abrasive cleansers on your unit.
4. Keep the unit dust free by wiping it with a soft, dry cloth.
5. Do not disassemble your unit, it contains no user-serviceable parts.

## **Frequently asked questions**

**Q Why won't my ZXT-120 work with the Z-Wave devices I purchased from another country?**

A Due to different countries regulations Z-Wave products from different regions are set to different frequencies. Before purchasing new devices make sure you have checked that the device is compatible in your region.

**Q How do I know which product is compatible with my ZXT-120?**

A ZXT-120 should work with any Z-Wave controller or gateway that has control capability for "Thermostat" devices. All Z-Wave products also come with the Z-Wave logo.



**Q Can I use the USB port to configure ZXT-120?**

A No, the mini USB port only provides an alternative option for user to power the ZXT-120.

**Q Do I need an electrician to install Z-Wave products in my house?**

A Installation can be simple. In some cases all you need to do is mount the ZXT-120 to a wall or wooden racks. You also can place the ZXT-120 on the desk and power it with dry cell batteries.

**Q How to select my air-conditioner IR code from ZXT-120?**

A You should refer to the code list and look into the brand and try the code no. sequentially until you find the right code. You can record down your device code under the table for future reference after setting up the ZXT-120 correctly.

**Q ZXT-120 is working on top and 4-directions IR output, but there is no response on the IR emitter socket, why?**

A ZXT-120 supports two IR power levels for the external IR emitter to avoid saturation of the IR receiver. You can set the IR output power level by the Parameter Table value (normal or high power mode) or adjust the position of your external IR emitter.

**Q Can I use 2 or more ZXT-120 in my house? What is the max. units if yes?**

A Yes and it is very depend on the capability of gateway / controller. For example, gateway can supports up to 8, 16 or 32 ZXT-120 in a network.

**Q How to avoid the IR interference if I am using 2 identical air-conditioners in same location but want to control them individually?**

A User can disable the Surround IR Output function, connect the external IR emitter and aim it at the specific AC unit. The operating distance of external IR emitter is around 100cm (High power mode) and 50cm (Low power mode) but it is also depends on the sensitivity of the IR receiver.

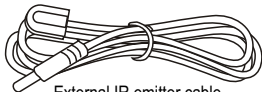

External IR emitter cable



## Technical Specifications

<b>Model no.</b>	BW8377EU (ZXT-120EU) BW8377AU (ZXT-120AU) BW8377US (ZXT-120US) BW8377IN (ZXT-120IN) BW8377RU (ZXT-120RU) BW8377IL (ZXT-120IL) BW8377CN (ZXT-120CN)
<b>RF frequency</b>	868.42MHz (ZXT-120EU) 921.42MHz (ZXT-120AU) 908.42MHz (ZXT-120US) 865.22MHz (ZXT-120IN) 869.02MHz (ZXT-120RU) 916.02MHz (ZXT-120IL) 868.42MHz (ZXT-120CN)
<b>RF operating distance</b>	up to 80ft outdoor line of sight, in unobstructed environment
<b>IR operating distance</b>	up to 25ft line of sight, in unobstructed environment
<b>IR learning</b>	Max. 23 commands
<b>Temperature</b>	Measurable range: 32 ~ 104 °F / 0~ 40 °C Report resolution: 1 degree C Operation: 0 ~ 40 °C Storage: -20 ~ 60 °C
<b>Powered by</b>	USB Power DC 5V 100mA or Dry battery AAA x 3pcs
<b>Dimension</b>	Dia.=70mm, T = 18mm (Main unit) Dia.=70mm, T = 15.5mm (Battery chassis)
<b>Weight</b>	35g (Battery chassis excluded) 60g (Battery chassis included) 90g (Main + Battery chassis + AAA x3pcs)

## **Checking Accessories**

After opening the cover of the packing box, check that the following accessories are included.

- ZXT-120 (Z-Wave-to-AC IR Extender)
- Screws (bottom cover) x 2pcs
- AC Code List
- USB cable
- User Manual
- Warranty sheet

## **FCC Notice**

This device complies with Part 15 of the FCC rules. Operation is subject to the following two conditions:

- (1) this device may not cause harmful interference, and
- (2) this device must accept any interference received, including interference that may cause undesired operation.

NOTE: This equipment has been tested and found to comply with the limits for a Class B digital device, pursuant to Part 15 of the FCC Rules. These limits are designed to provide reasonable protection against harmful interference in a residential installation. This equipment generates, uses and can radiate radio frequency energy and, if not installed and used in accordance with the instructions, may cause harmful interference to radio communications. However, there is no guarantee that interference will not occur in a particular installation. If this equipment does cause harmful interference to radio or television reception, which can be determined by turning the equipment off and on, the user is encouraged to try to correct the interference by one or more of the following measures:

- Reorient or relocate the receiving antenna.
- Increase the separation between the equipment and receiver.
- Connect the equipment into an outlet on a circuit different from that to which the receiver is connected.
- Consult the dealer or an experienced radio/TV technician for help.

Notice: Changes or modifications to this unit not expressly approved by the party responsible for compliance could void the user authority to operate the equipment.

## **Warnings**

- Do not modify the unit in any way.
- Risk of fire.
- Risk of electrical shock.
- Risk of burns.
- Do not dispose of electrical appliances and unsorted municipal waste, use separate collection facilities. Contact your local government for information regarding the collection systems available.
- There is no user serviceable parts in this unit.
- The socket-outlet shall be installed near the equipment and shall be easily accessible.
- Use only power supplies listed in the user instructions.

## **Caution**

- Risk of explosion if battery is replaced by an incorrect type.
- Dispose of used batteries according to the instructions.

