

# ENERGIZER E92

**AAA**

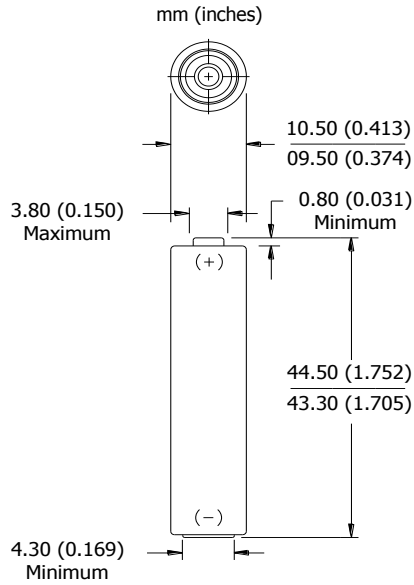

## Industry Standard Dimensions



## Specifications

<b>Classification:</b>	Alkaline
<b>Chemical System:</b>	Zinc-Manganese Dioxide (Zn/MnO <sub>2</sub> ) No added mercury or cadmium
<b>Designation:</b>	ANSI-24A, IEC-LR03
<b>Nominal Voltage:</b>	1.5 volts
<b>Nominal IR:</b>	150 to 300 milliohms (fresh)
<b>Operating Temp:</b>	-18°C to 55°C (0°F to 130°F)
<b>Typical Weight:</b>	11.5 grams (0.4 oz.)
<b>Typical Volume:</b>	3.8 cubic centimeters (0.2 cubic inch)
<b>Jacket:</b>	Plastic Label
<b>Shelf Life:</b>	10 years at 21°C
<b>Terminal:</b>	Flat Contact

## Milliamp-Hours Capacity

Continuous discharge to 0.8 volts at 21°C

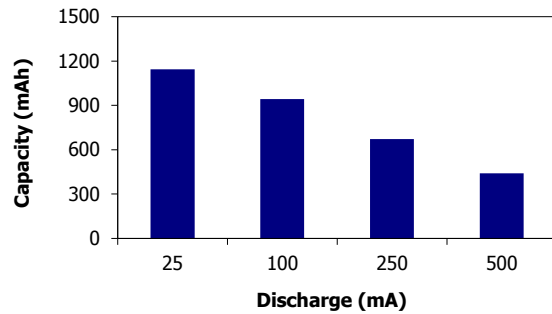

## Constant Power Performance

Typical Characteristics (21°C)

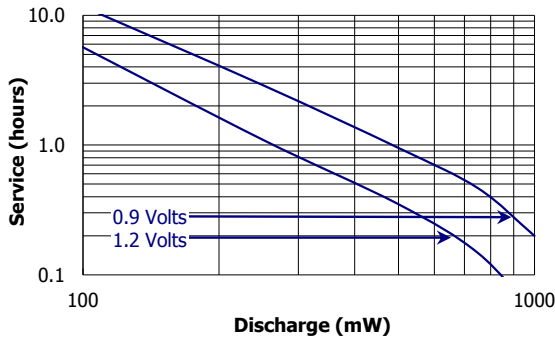

## Constant Current Performance

Typical Characteristics (21°C)

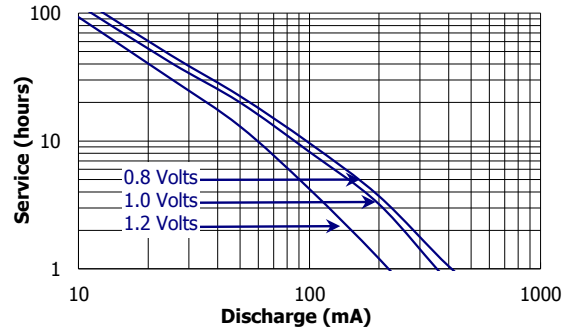

**ENERGIZER E92**

**AAA**

**Constant Power Performance**

Discharge Characteristics (21°C)

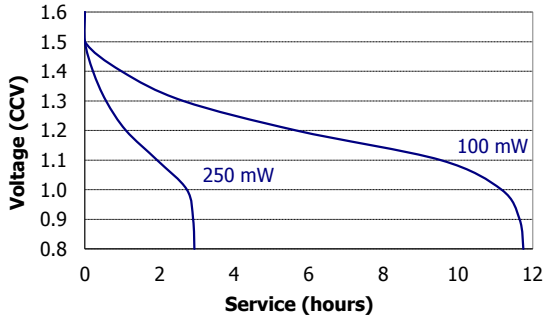

**Constant Current Performance**

250 mA Discharge (-20°C / 0°C / 21°C)

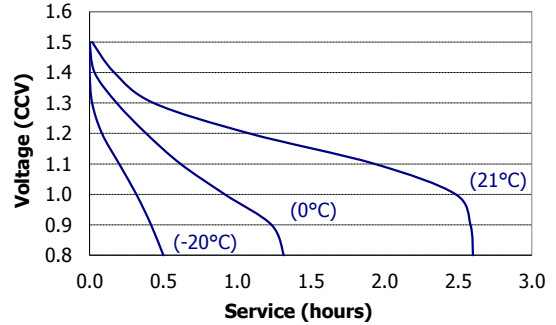

**Industry Standard Tests (21°C)**

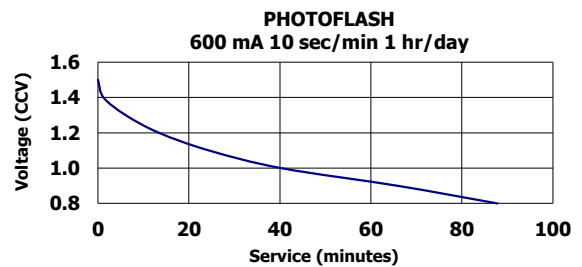
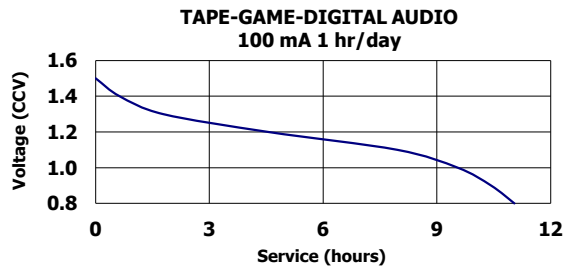
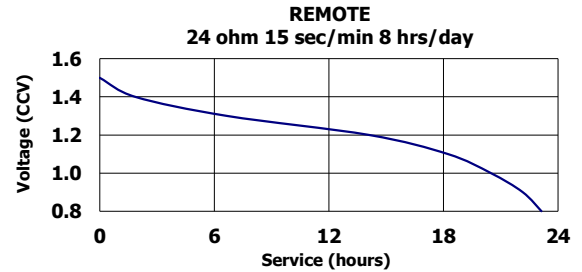
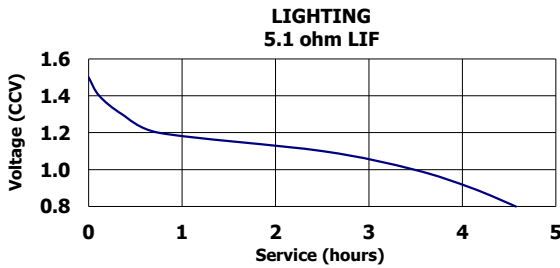

- Pack Quantity : 4
- Manufacturers Part Number : E300124200
- Pack Quantity : 8
- Manufacturers Part Number : E300112100
- Pack Quantity : 12
- Manufacturers Part Number : E300103700