

4 WIRE APARTMENT SYSTEM MONITOR

KCV-504·D504

- 7" Color digital LCD monitor
- Easy to operate using OSD menu and icon button
- Communication between Door camera, Guard phone and Lobby phone
- Connection up to 1 Door camera and 1 monitor

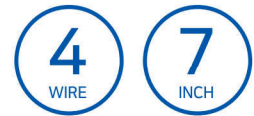

COLOR



BLACK



WHITE

SPECIFICATIONS

| | | |
|-----------------------|----------------------------------|----------------------------|
| Model No. | KCV-504 | KCV-D504 |
| Power Source | AC 100-240V, 50/60Hz | DC 15V-2A(JPW128KA1502N05) |
| Power Consumption | Stand by 1.5W, In load 11W(±20%) | |
| LCD | 7" Digital LCD | |
| Communication System | Hands-free Type | |
| Operating Temperature | 0°C ~ +40°C | |
| Mount Type | Surface mount | |
| Dimesion | 223(W) x 130(H) x 26(D) mm | |

WIRING DIAGRAM

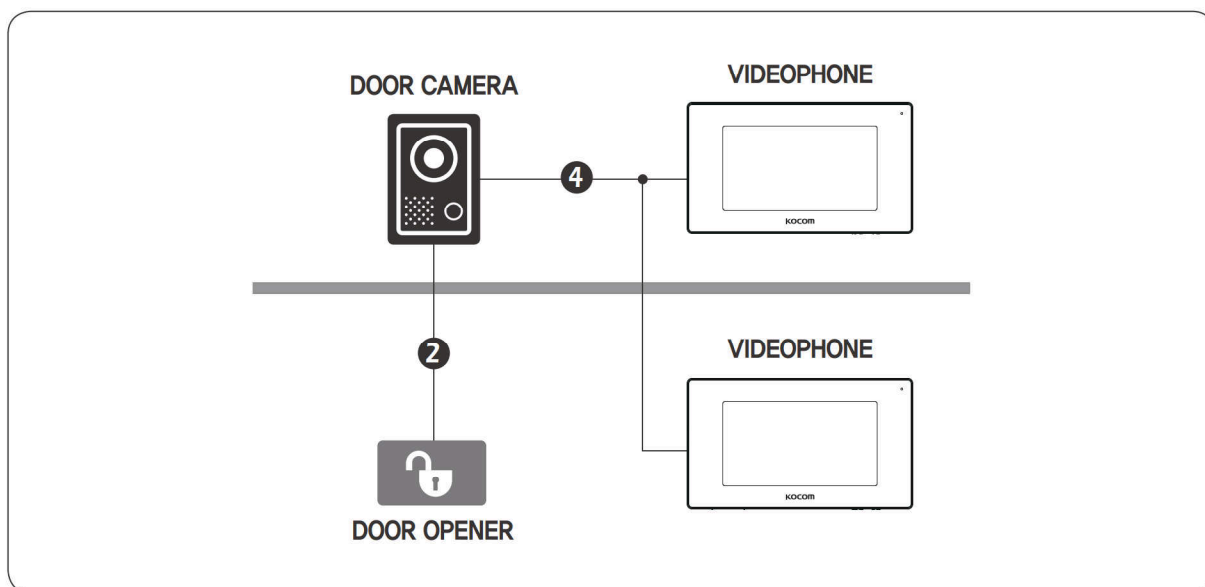

PRODUCT DIMENSION

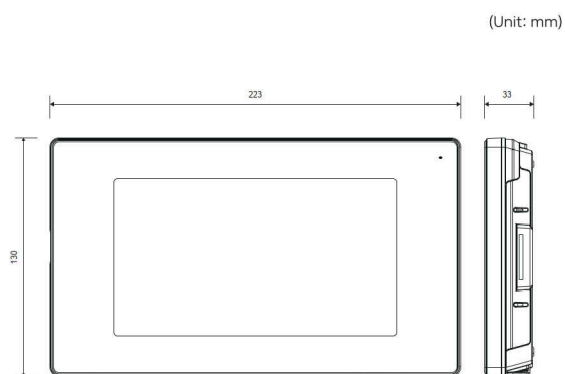

CONNECTABLE PRODUCT



DOOR CAMERA
KC-S81M NEW



SPECIFICATIONS

| | |
|-------------------|-------------------------------|
| Power | DC 11V±1V(power from monitor) |
| Power Consumption | Max. 3W |
| Wiring | 4 Wire |
| Body Material | Metal |
| Mount Type | Surface mount |
| Camera Angle | 100 ° (Angle Abjustable) |
| Min. Illumination | 0.1 lux(LED ON) |
| Dimesion | 70(W) x 125(H) x 21(D)mm |

WIRING

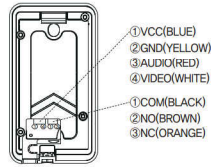

DOOR CAMERA
KC-94 NEW



SPECIFICATIONS

| | |
|-------------------|-------------------------------|
| Power | DC 12V±1V(power from monitor) |
| Power Consumption | Max. 2,5W |
| Wiring | 4 Wire |
| Body Material | Plastic |
| Mount Type | Flush mount |
| Camera Angle | 100 ° (Angle Abjustable) |
| Min. Illumination | 0.1 lux(LED ON) |
| Dimesion | 89(W) x 131(H) x 13(D)mm |

WIRING

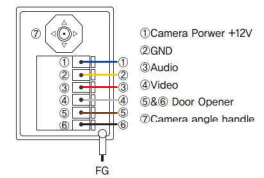

DOOR CAMERA
KC-MC30



SPECIFICATIONS

| | |
|-------------------|-------------------------------|
| Power | DC 12V±1V(power from monitor) |
| Power Consumption | Max. 2,5W |
| Wiring | 4 Wire |
| Body Material | Metal |
| Mount Type | Surface mount |
| Camera Angle | 100 ° (Angle Abjustable) |
| Min. Illumination | 0.1 lux(LED ON) |
| Dimesion | 110(W) x 158(H) x 39(D)mm |

WIRING

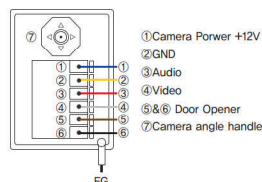

DOOR CAMERA
KC-C60



SPECIFICATIONS

| | |
|-------------------|-------------------------------|
| Power | DC 12V±1V(power from monitor) |
| Power Consumption | Max. 2,5W |
| Wiring | 4 Wire |
| Body Material | Plastic |
| Mount Type | Surface mount |
| Camera Angle | 100 ° (Fixed) |
| Min. Illumination | 0.1 lux(LED ON) |
| Dimesion | 95(W) x 12(H) x 34(D)mm |

WIRING

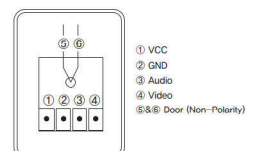

Full Mirror Front



26mm Ultra Slim Design



KCV-504/D504

 **Handsfree Videophone**
KCV-504/D504

Compact Slim Design(26mm) | 7 inch digital LCD color monitor | Full Mirror Front
Easy Icon Button | OSD function | Visitor Communication and Door Open
Communicate with Guard Master phone | Touch button | Guard Phone, Lobby Phone Operating

Monitor for KCV-504 / KCV-D504



Transparent(Black)

Transparent(White)

Mirror(Black)

Mirror(White)

Camera for KCV-504 / KCV-D504



KC-MC24

KC-C60

KC-MC20

KC-MC30

KLP-C410

System configurations (Cam Mode)

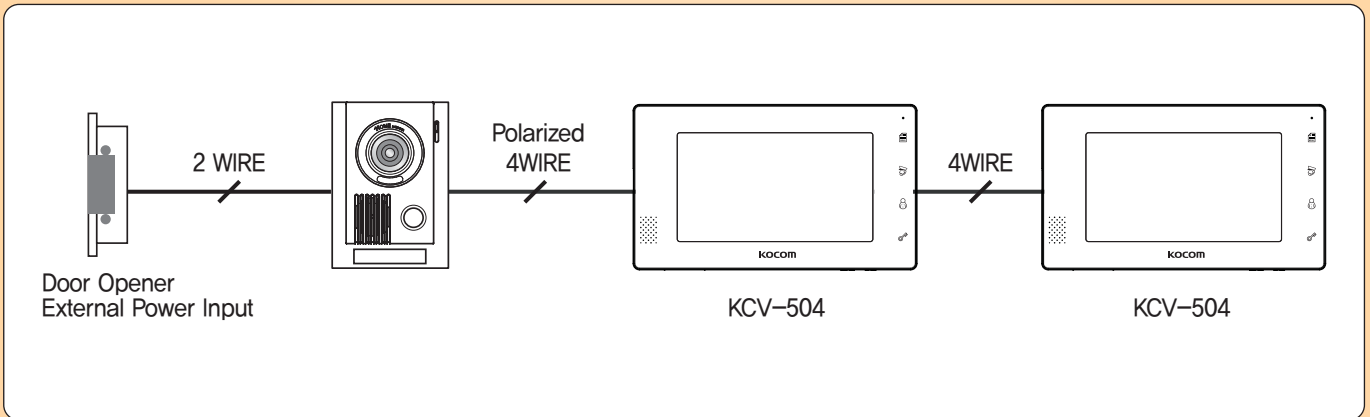

System configurations (System Mode)

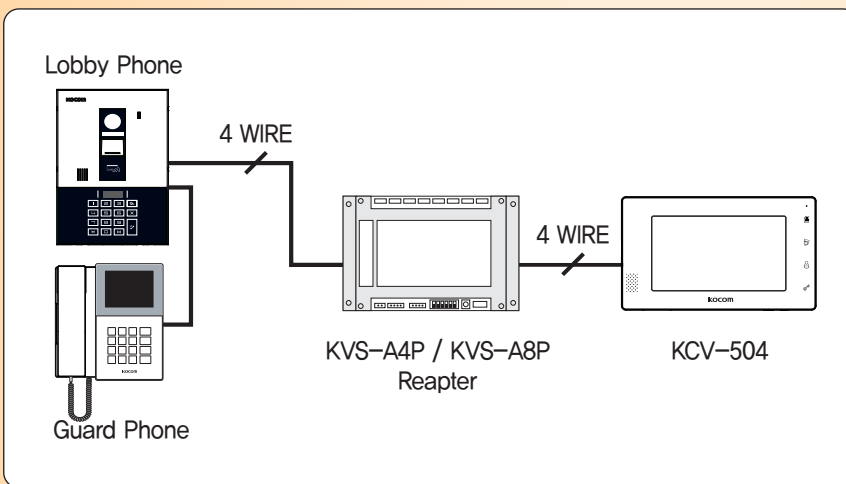

Camera connection wiring

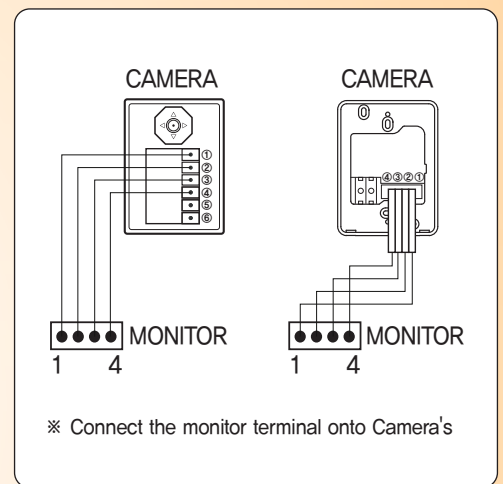

* Caution for Camera Installation

When turned on, the monitor automatically detects if video signal(CAM1) is NTSC or PAL.
So, after connecting camera(CAM1), the monitor should be turned on again.

Specifications

| Monitor | Model number | KCV-504 | | KCV-D504 | |
|-------------|----------------------------|---|--------------------------|----------------------------|--------------------------|
| | Power Source | AC90V-AC240V 50/60Hz | | DC 15V-2A(JPW128KA1502N05) | |
| | Power Consumption | Stand by 1W, In load 8.5W(±20%) | | | |
| | Operating Temperature | 0°C ~ +40°C | | | |
| | LCD | 7 Inch color LCD | | | |
| | Communication System | Handsfree type | | | |
| | Wiring | Door camera wiring - Polarized 4 lines (VCC[12V] / GND / VOICE / VIDEO) | | | |
| | Mount Type | Surface mount | | | |
| Dimension | 223(W) x 130(H) x 26(D) mm | | | | |
| Door Camera | Model number | KC-MC30 | KC-MC24 | KC-C60 | KC-MC20 |
| | Power Source | DC 12V±1V(Power from Monitor) | | | |
| | Power Consumption | Max. 3W | | | |
| | Operating | -10°C ~ +50°C | | | |
| | Dimension | 110(W) x 158(H) x 39(D)mm | 96(W) x 127(H) x 32(D)mm | 95(W) x 127(H) x 34(D)mm | 40(W) x 120(H) x 22(D)mm |
| | Angle of Lens | Diagonal 120° (angle adjustable) | Diagonal 90° | Diagonal 90° | Diagonal 90° |

* Door Camera Wiring - Polarized 4 lines (VCC[12V]/GND/VOICE/VIDEO)