

4 WIRE APARTMENT SYSTEM MONITOR

# KCV-544SD · D544SD NEW

- 7" Color digital LCD monitor • Customer-customized UI/Full Touch Screen
- Compatible with 1080p(FHD) AHD CCTV (TVI , AHD , CVI)
- CCTV Motion Detection / Recording function(1080P)
- Connection up to 2 Door Cameras and 2 Monitors or 1 Door camera and 1 CCTV camera with Sub- interphone (KIP-32G)
- Internal Communication between indoor units • Multifamily, Application (KLP-C420 SYSTEM)
- Compatible with SDXC 128GB(MAX) Micro SD CARD
- Auto Video Recording(Door Camera) • e-Album (includes music function)

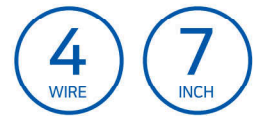

## COLOR

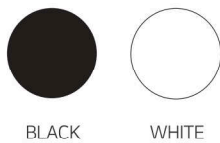

## SPECIFICATIONS

Model No.	KCV-544SD	KCV-D544SD
Power Source	AC100-240V, 50/60Hz	DC 15V-2A
Power Consumption	5W(Standby), 12W(Max.)	
LCD	7" Digital LCD	
Communication System	Hands-free Type	
Operating Temperature	0°C ~ +40°C	
Mount Type	Surface mount	
Dimension	223(W) X 130(H) X 33(D) mm	

# WIRING DIAGRAM

## Camera mode diagram

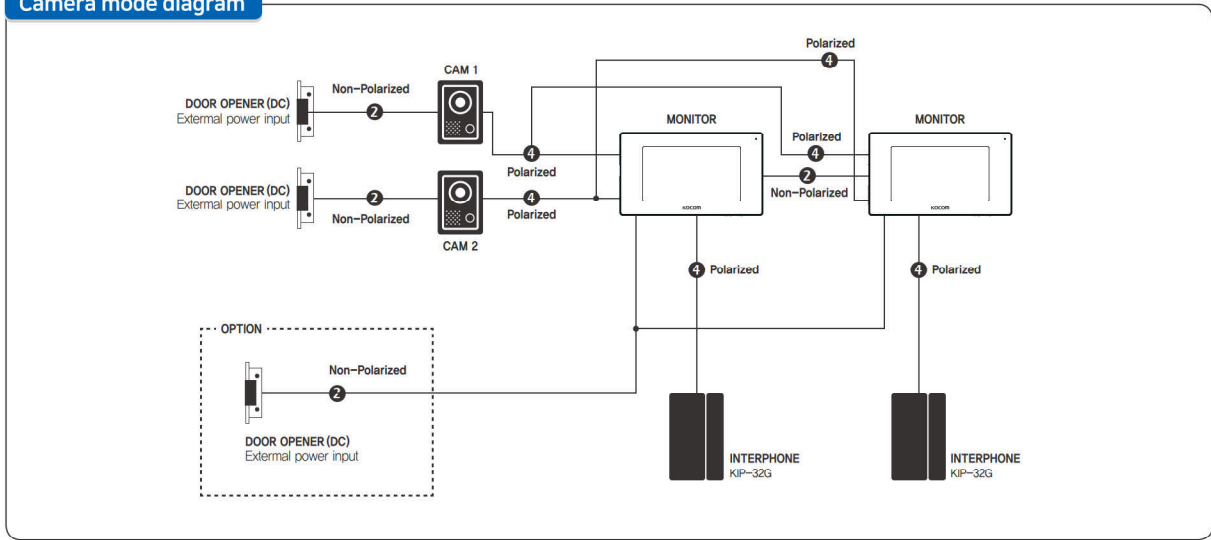

## Camera & CCTV mode Diagram

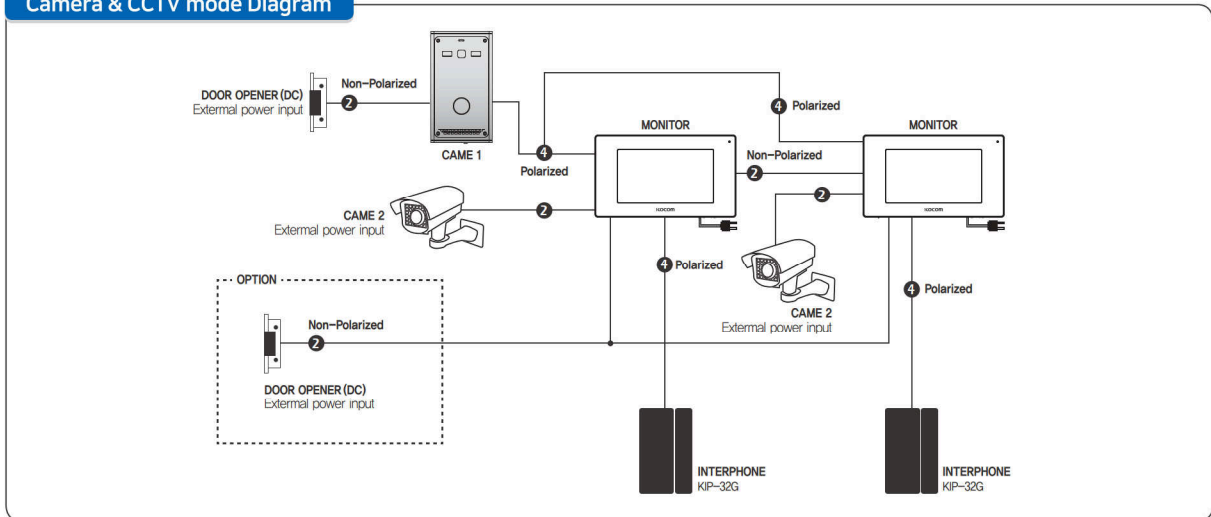

# PRODUCT DIMENSION

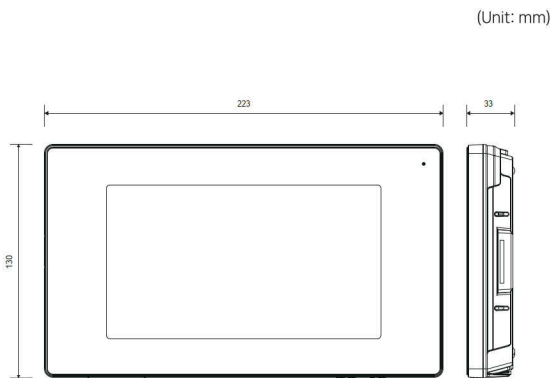

# CONNECTABLE PRODUCT



DOOR CAMERA  
**KC-S81M** NEW



**SPECIFICATIONS**

Power	DC 11V±1V(power from monitor)
Power Consumption	Max. 3W
Wiring	4 Wire
Body Material	Metal
Mount Type	Surface mount
Camera Angle	100 ° (Angle Abjustable)
Min. Illumination	0.1 lux(LED ON)
Dimesion	70(W) x 125(H) x 21(D)mm

**WIRING**

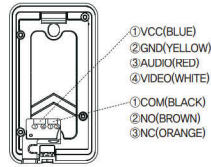

DOOR CAMERA  
**KC-94** NEW



**SPECIFICATIONS**

Power	DC 12V±1V(power from monitor)
Power Consumption	Max. 2,5W
Wiring	4 Wire
Body Material	Plastic
Mount Type	Flush mount
Camera Angle	100 ° (Angle Abjustable)
Min. Illumination	0.1 lux(LED ON)
Dimesion	89(W) x 131(H) x 13(D)mm

**WIRING**

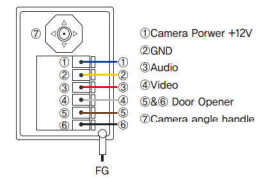

DOOR CAMERA  
**KC-MC30**

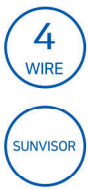

**SPECIFICATIONS**

Power	DC 12V±1V(power from monitor)
Power Consumption	Max. 2,5W
Wiring	4 Wire
Body Material	Metal
Mount Type	Surface mount
Camera Angle	100 ° (Angle Abjustable)
Min. Illumination	0.1 lux(LED ON)
Dimesion	110(W) x 158(H) x 39(D)mm

**WIRING**

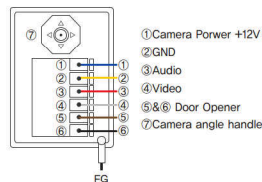

DOOR CAMERA  
**KC-C60**



**SPECIFICATIONS**

Power	DC 12V±1V(power from monitor)
Power Consumption	Max. 2,5W
Wiring	4 Wire
Body Material	Plastic
Mount Type	Surface mount
Camera Angle	100 ° (Fixed)
Min. Illumination	0.1 lux(LED ON)
Dimesion	95(W) x 12(H) x 34(D)mm

**WIRING**

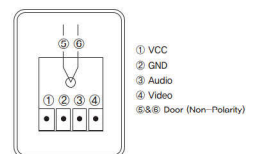

# KOCOM

## VIDEOPHONE

# KCV-544SD

**Full Touch** SCREEN **AHD CCTV** CONNECTION



MICRO SD CARD



Motion Detection



GUI Menu



LCD

1024 x 600



Door Open



Plug & Play

- High resolution 1024 X 600 Color Digital LCD (NTSC / PAL Auto switching)
- Slim, Compact & Luxury Design
- Full Touch capacitive screen
- Easy to operate using GUI
- Digital Photo Album
- Digital Video Recorder
  - Motion Detection
  - Memory Size : up to 128Gb(SDXC)
  - Video Format : Moving picture (H.264), Still cut : JPEG
- Multiple language support : English, Spanish and Russian
- Connection up to 2 Door cameras or 1 Door Camera and 1 CCTV camera with 2 monitors and 2 sub audio phone(KIP-32G)
- Call & Communication with visitor & Door open function
- Door Opener Connectable from Either Monitor or Camera

MADE IN KOREA



Compatible Door Cameras



KC-Q81P



KC-MC24



KC-MC20



KC-MC30

# FULL HD MEMORY VIDEOPHONE KCV-544SD SDXC

*Kocom's High Performance & High Quality Security phone protects your life*

Perfect Item for Your Security & Home Decoration, Easy to Install Everywhere like Single House, Multi Apartment, Condominium & Villa.



General Screen



KCV-544SD Screen

## • Bright and Clear Image

Thanks to Kocom's LED technology, brightness and image quality are improved more than 50%.



## • 4 wire Easy Installation

Anyone can install only with 4 wires easily.



## • GUI & Full Touch Capacitive Screen

Convenient and easy to operate using Full Touch GUI.



## • Photo Album

Keep your valuable photo in SD card & easily Check using KCV-544SD whenever you want.

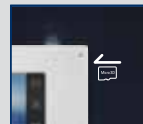

## • SD Card interface(SDXC)

Being Applied SD Card Interface, KCV-544SD works as a Triple Functioning Equipment like a Videophone, Photo Album, and Mini DVR.



## • Mini DVR

Connecting CCTV cameras and saving moving picture are freely available like a Mini DVR



## • High definition 1080P CCTV(Full HD)

AHD / TVI / CVI connection

## System Diagram

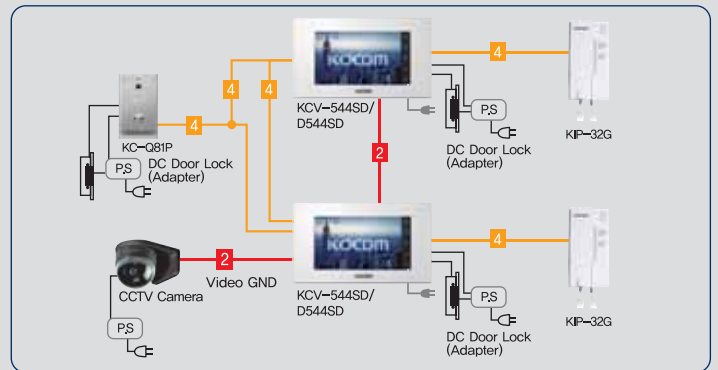
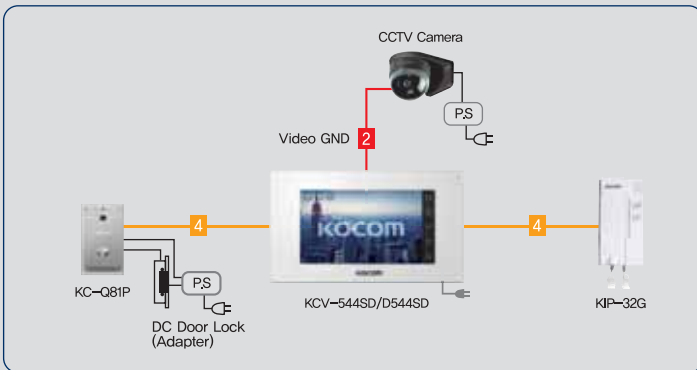

## Wiring Diagram

### • Camera Connection

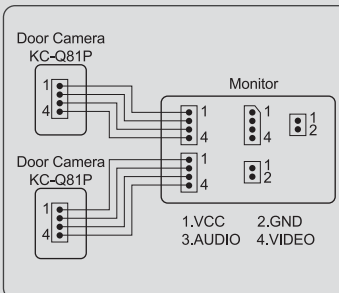

### • Sub Audio Phone Connection

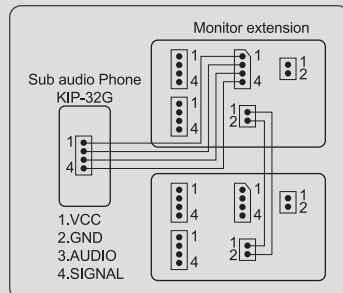

## Specifications

Model No.	KCV-544SD	KCV-D544SD
Power Source	AC100-240V, 50/60Hz	DC 15V-2A
Power Consumption	5W(Standby), 12W(Max.)	
LCD	7" Digital LCD	
Communication System	Handsfree type	
Operating Temperature	0°C ~ +40°C	
Mount Type	Surface mount	
Dimension	223(W) X 130(H) X 33(D) mm	

# KOCOM

**KOCOM CO.,LTD.**

Head Office KOCOM BLDG., 22, Arayuk-ro, Gochon-eup, Gimpo-si, Gyeonggi-do, 10136, Korea

TEL : +82-2-6675-2211 | FAX : +82-2-6675-2000 | E-mail : export@kocom.com | www.kocom.com

※This catalog is based on the date as shown in the right and specifications are subject to change without notice for quality improvement.