

**Preliminary**

## 4 x FHD(8MP) Multi-Sensor Network Camera

Panasonic WV-S8531N captures the highest quality images in even very challenging and dynamic environments. In particular, the camera can capture clear vehicle image in color even at night intersections of low light intensity. And the four repositionable lenses minimize blind spots and flexibly correspond to intersections of various shapes and monitoring areas of cities. Intelligent Auto (iA) monitors scene dynamics and motion to adjust key camera settings automatically in real-time reducing distortion such as motion blur on moving objects. By adopting H.265 Smart Coding technology, bandwidth efficiency is intelligently increased for longer recording and less storage. Cameras out-of-the-box, use an encryption module standardized by FIPS Publication 140-2 for secure video streaming.

### Extreme image quality for evidence capturing under challenging conditions

- Four repositionable lenses with easy adjustment include a wide range tilt angle mechanism minimizes blind spots
- Sharp and clear images of fast moving vehicles with Intelligent Auto and ClearSight Coating
- Outstanding low light performance in true color with low noise for night time applications
- Super Dynamic 120dB for backlit situations and shadows on night streets
- Environmental durability : IP66, IK10 and Dehumidification device

### Extreme bandwidth compression with new Panasonic H.265 Smart Coding

- Reduced the amount of transferred data and less storage space compared to any H.264 based compression techniques
- New self-learning ROI\* encoding (Auto VIQS) dynamically detect motion areas to keep vehicles and human in good picture quality while lowering your bandwidth \*Region of Interest

### Extreme Data Security

- Full encryption SD card edge recording to keep your data safe
- FIPS140-2 CAVP compliant \*Using encryption module standardized by FIPS publication 140-2
- Full end-to-end system encryption with supported VMS and devices to protect from IP snooping/spoofing and detect data alteration

### Easy installation

- Continuous view assistance: After determining the monitor angle, set the lens to the specified position and the cameras will automatically zoom and focus to reduce the overlap of images from each camera.
- Installation time can be reduced by confirming live image and adjusting viewing angle with smartphone or tablet device via Wi-Fi connection.
- Allows you to connect the network cable to the camera body simply by opening a part of the package, which saves you time and workspace, especially when handling multiple cameras.

### Key Features

- 4 x FHD(8MP) 1600x1200 / 1920x1080 up to 30fps
- iA (intelligent Auto)
- Super Dynamic 120dB
- Color night vision (0.006 to 0.09 lx)
- H.265 Smart Coding
- ClearSight Coating
- Continuous view assistance
- Wide range tilt angle adjustment mechanism

### Industry examples

- Public safety (City / Highway toll / Parking gate)
- Transportation (Airport / Train / Subway)



\*The actual product may differ.

**PRO**

## Wide range tilt angle adjustment mechanism

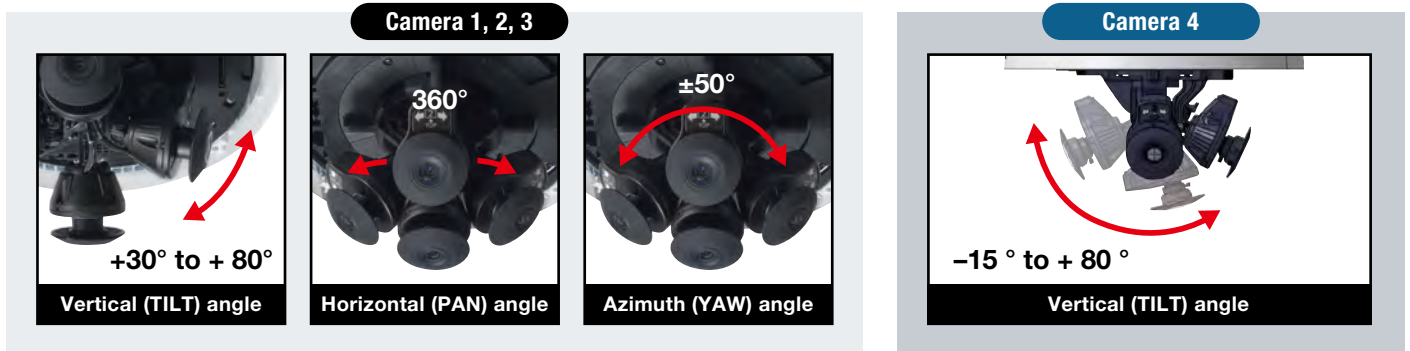

\*The above is the adjustable range of a single camera. The adjustable range of each camera varies according to the positional relationship with other cameras.

## Four repositionable lenses enables to monitoring at minimize blind spots

### 270-degree view (Full intersection view)

- One multi sensor camera at intersection corner, It enables monitoring with minimized blind spots
- Enables to monitoring even if bottom view angle

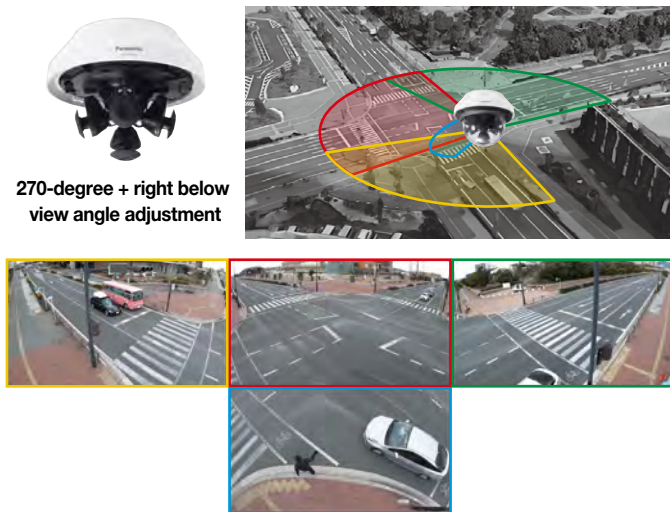

### 360-degree view

- One multi-sensor camera enables monitor the park by minimize blind spots



## Usability - Easy setting

- Installation time can be reduced by confirming live image and adjusting viewing angle with smartphone or tablet device via Wi-Fi connection.

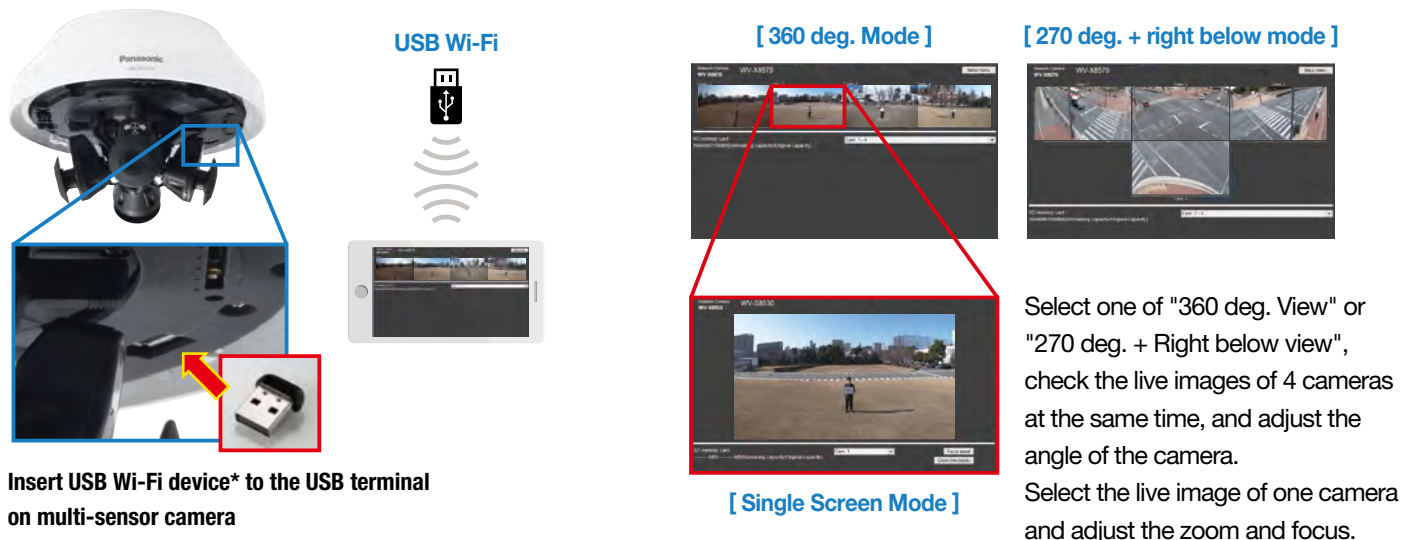

Insert USB Wi-Fi device\* to the USB terminal on multi-sensor camera

\*Be sure to use a Wi-Fi USB adapter that is checked its operability by Panasonic.

## Specifications

<b>Camera</b>	Image Sensor	1/3 type CMOS image sensor	
	Minimum Illumination	Color : 0.09 lx, BW : 0.04 lx (F2.0, Maximum shutter : Off (1/30s), AGC : 11) Color : 0.006 lx, BW : 0.003 lx (F2.0, Maximum shutter : max. 16/30s, AGC : 11) <sup>*1</sup>	
	Intelligent Auto	On / Off	
	Maximum shutter	30 fps mode: Max.1/10000s to Max.16/30s 25 fps mode: Max.1/10000s to Max.16/25s	
	Super Dynamic	On / Off, The level can be set in the range of 0 to 31.	
	Dynamic Range	Max.120 dB typ. (Super Dynamic : On, level : 31)	
	Image Settings	Gain (AGC), White balance	
	Image Compensation	Adaptive black stretch, Back light compensation (BLC), High light compensation (HLC), Fog compensation, Digital noise reduction	
	Color/BW (ICR)	Off / On / Auto1 (Normal) / Auto2 (IR Light) / Auto3 (SCC)	
	Video Motion Detection (VMD)	On / Off, 4 areas available	
	Privacy Zone	On / Off, up to 8 zones available	
	Upside-down	On / Off	
	Camera Title (OSD)	On / Off, Up to 20 characters (alphanumeric characters, marks)	
	Adjusting angle	Camera 1, 2, 3 : Horizontal (PAN) angle : 360 ° Vertical (TILT) angle : +30 ° to + 80 ° Azimuth (YAW) angle : ±50 ° Camera 4 : Horizontal (PAN) angle : 360 ° Vertical (TILT) angle : -15 ° to + 80 ° Azimuth (YAW) angle : ±50 ° *The above is the adjustable range of a single camera. The adjustable range of each camera varies according to the positional relationship with other cameras.	
	<b>Lens</b>	Zoom Ratio	2.5x Optical zoom (Motorized zoom / Motorized focus) 7.5x Extra Optical Zoom (when resolution is 640x360)
		Digital (electronic) zoom	Choose from 3 levels of x1, x2, x4
		Focal length	3.2 mm – 5.7 mm {1/8 inches - 7/32 inches}
Maximum Aperture Ratio		1 : 2.0 (WIDE) – 1 : 3.0 (TELE)	
Focus range		1.5 m (4.92 feet) – ∞	
Angular Field of view with one lens		[16 : 9] Horizontal : 45 ° (TELE) – 104 ° (WIDE) Vertical : 25 ° (TELE) – 58 ° (WIDE)	
<b>Browser GUI</b>	Camera Control	Brightness	
	GUI / Setup Menu Language	English, Italian, French, German, Spanish, Portuguese, Russian, Chinese, Japanese	
<b>Network</b>	Network IF	10Base-T / 100Base-TX / 1000Base-T, RJ45 connector	
	Resolution with one lens	[16 : 9 mode] *Cannot be changed. 1920 x 1080 / 1280 x 720 / 640 x 360 / 320 x 180	
	H.265/ Transmission Mode	Constant bit rate / VBR / Frame rate / Best effort	
	H.264*2/ Transmission Type	Unicast port(AUTO) / Unicast port(MANUAL) / Multicast	
	JPEG Image Quality	10 steps	
Smart Coding	<b>GOP (Group of pictures) control :</b> On (Frame rate control) / On (Advanced)* / On (Mid) / On (Low) / Off *On (Frame rate control) and On (Advanced) are only available with H.265. <b>Auto VIQS : On / Off</b>		

<b>Network</b>	Supported Protocol	IPv6 : TCP/IP, UDP/IP, HTTP, HTTPS, SMTP, DNS, NTP, SNMP, DHCPv6, RTP, MLD, ICMP, ARP, IEEE 802.1X, DiffServ IPv4 : TCP/IP, UDP/IP, HTTP, HTTPS, RTSP, RTP, RTP/RTCP, SMTP, DHCP, DNS, DDNS, NTP, SNMP, UPnP, IGMP, ICMP, ARP, IEEE 802.1X, DiffServ
	Maximum concurrent access number	Up to 24 users (Depends on network conditions)
	SDXC/SDHC/SD Memory Card	H.265 / H.264 recording : Manual REC / Alarm REC (Pre/Post) / Schedule REC Compatible SDXC/SDHC/SD card : Panasonic 2 GB, 4 GB*, 8 GB*, 16 GB*, 32 GB*, 64 GB**, 128 GB**, 256 GB** model *SDHC card, ** SDXC card (except miniSD card and microSD card)
	Mobile Terminal Compatibility	iPad / iPhone, Android™ terminals
<b>Alarm</b>	Alarm Source	VMD alarm, Command alarm
	Alarm Actions	SDXC/SDHC/SD memory recording, E-mail notification, HTTP alarm notification, Indication on browser, Panasonic alarm protocol output
<b>General</b>	Safety	UL (UL60950-1), c-UL (CSA C22.2 No.60950-1), CE, IEC60950-1
	EMC	FCC (Part15 ClassA), ICES003 ClassA, EN55032 ClassB, EN55024
	Power Source and Power Consumption	PoE+ (IEEE802.3at compliant): DC 54V 390 mA, Approx. 22 W(Class4 device)
	Ambient Operating Temperature	-40 °C to +60 °C (-40 °F to +140 °F)
	Ambient Operating Humidity	10 to 100 % (no condensation)
	Dehumidification Device	Rosahl element
	Water and Dust Resistance	IP66 (IEC60529), Type 4X (UL50), NEMA 4X compliant
	Shock Resistance	IK10 (IEC62262)
	Wind Resistance	Up to 40 m/s (approx. 89 mph)
	Dimensions	<b>When using the attachment plate only :</b> ø230 mm x 196 mm (H) {ø9-1/16 inches x 7-23/32 inches (H)}, Dome radius 80 mm (3-5/32 inches)
	Mass (approx.)	<b>When using the attachment plate only :</b> Approx. 2.7 kg (5.95 lbs)
Finish	Main body : Aluminum die cast, i-PRO white, Outer fixing screws : Stainless steel (Corrosion-resistant treatment) Dome cover : Polycarbonate resin (with ClearSight coating), Clear	

\*1 Converted value

\*2 H.265/H.264 can be selected for each stream.





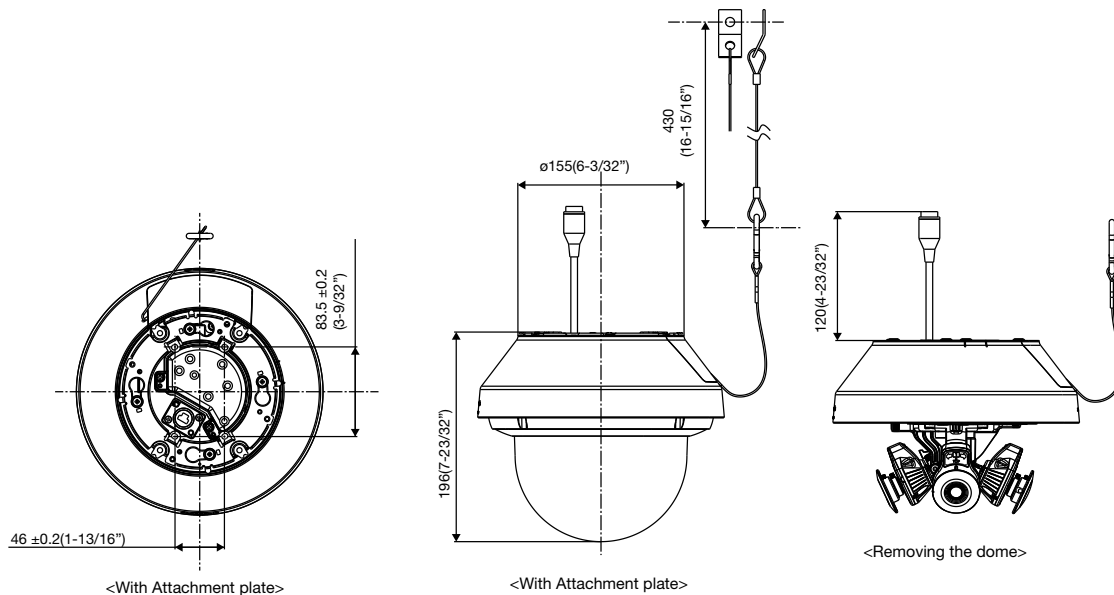



## Appearance

Unit : mm (inches)



## Optional Accessories

### Mount Bracket / Other

<p>Ceiling Mount Bracket <b>WV-Q105A</b></p>  <p>*For indoor installation only</p>	<p>Base Bracket <b>WV-QJB501-W</b> (i-PRO white)</p> 	<p>Mount Bracket <b>WV-QSR502A-W</b> (i-PRO white)</p>  <p>(This bracket requires WV-QCL501-W, WV-QWL501-W or WV-QAT500-W.)</p>	<p>Ceiling Mount Bracket <b>WV-QCL501-W</b> (i-PRO white)</p>  <p>(This bracket requires WV-QSR502A-W.)</p>	<p>Wall Mount Bracket <b>WV-QWL501-W</b> (i-PRO white)</p>  <p>(This bracket requires WV-QSR502A-W.)</p>	<p>Pole Mount Bracket <b>WV-QPL500-W</b> (i-PRO white)</p>  <p>(This bracket requires WV-QWL501-W.)</p>
<p>Corner Mount Bracket <b>WV-QCN500-W</b> (i-PRO white)</p>  <p>(This bracket requires WV-QWL501-W.)</p>	<p>Attachment pipe (For 3rd party bracket) <b>WV-QAT500-W</b> (i-PRO white)</p>  <p>(This bracket requires WV-QSR502A-W.)</p>				

• Brackets are available in four colors, Fine silver, Light gray, Gray and i-PRO white. It is possible to use them in different color combinations.

#### Important

- Safety Precautions : Carefully read the Basic Information, Installation Guide and Operating Instructions before using this product.
- Panasonic cannot be held responsible for the performance of the network and/or other manufacturers' products used on the network.

#### Trademarks and registered trademarks

- iPad and iPhone are trademarks of Apple Inc., registered in the U.S. and other countries.
- Android is a trademark of Google LLC.
- All other trademarks identified herein are the property of their respective owners.
- Masses and dimensions are approximate. • Specifications are subject to change without notice.

# Panasonic®

Panasonic Corporation

Panasonic i-PRO Sensing Solutions Co., Ltd.

<https://ipro.panasonic.com>

<https://security.panasonic.com>

<https://www.linkedin.com/company/i-pro-sensing-solutions-co-ltd/>

(2A-274A)